

# **WT32 EVALUATION KIT**

DATA SHEET

Friday, 03 October 2008

Version 2.1

## **Copyright © 2000-2008 Bluegiga Technologies**

All rights reserved.

Bluegiga Technologies assumes no responsibility for any errors which may appear in this manual. Furthermore, Bluegiga Technologies reserves the right to alter the hardware, software, and/or specifications detailed here at any time without notice and does not make any commitment to update the information contained here. Bluegiga's products are not authorized for use as critical components in life support devices or systems.

The WRAP, Bluegiga Access Server, Access Point and iWRAP are registered trademarks of Bluegiga Technologies.

The *Bluetooth* trademark is owned by the Bluetooth SIG Inc., USA and is licensed to Bluegiga Technologies. All other trademarks listed herein are owned by their respective owners.

## VERSION HISTORY

Version	Comment
1.0	Pra
1.1	MSa
2.0	Pra
2.1	MSa

## TABLE OF CONTENTS

1	Introduction .....	5
2	Physical outlook.....	6
3	Schematics .....	7
4	Assembly .....	13
5	Layout.....	14
6	Interfaces.....	18
6.1	Power Supply.....	18
6.2	Stereo Line Input and Output .....	18
6.3	Microphone Input.....	18
6.4	SPI interface .....	18
6.5	UART Interface .....	19
6.6	USB interface.....	19
7	WEEE Compliance .....	19
8	Contact Information .....	20

# 1 Introduction

## FEATURES

- USB cable
- Plantronics Stereo Headset
- Evaluation kit for WT32 *Bluetooth* audio module containing
  - 290 mAh Li-Pol battery with USB battery charger and a LED indicator
  - RS-232 serial interface with DTR button
  - USB interface
  - SPI for upgrading the firmware and parameters
  - Reset and 4 software configurable buttons
  - 3 x 2,5mm audio jacks for line in, line out and microphone
  - 16 pin I/O interface (PIO0 – PIO10, AIO0 – AIO1, PCM, UART, RESET, GND, 3V3)
  - Switchs for disabling RS232 driver and to connect a LED for PIO7
- Configurable audio interface consisting
  - A mono electric microphone input
  - A fully differential audio input / output through a pin header
  - Differential audio input and output through stereo jack connectors
- iWRAP™ firmware

## TARGET APPLICATIONS

WT32 Evaluation Kit is meant for evaluation and development of WT32 *Bluetooth* module or prototyping and piloting *Bluetooth* systems utilizing WT32 module.

## ELECTRICAL FUNCTIONALITY

Please, refer to the latest WT32 data sheet for information about WT32 *Bluetooth* module. The physical outlook, schematics, assembly and the PIN configurations of the interfaces of WT32 evaluation Kit are described in this document.

## SOFTWARE FUNCTIONALITY

WT32 evaluation kit is delivered with iWRAP software as default firmware. iWRAP is a simple ASCII based command interface, which enables access to various *Bluetooth* functions. A detailed description of iWRAP firmware can be found from *iWRAP User Guide* available in Bluegiga's Tech Forum.

## 2 Physical outlook



Figure 1: WT32 evaluation kit, Onboard Installation Kit and headphones







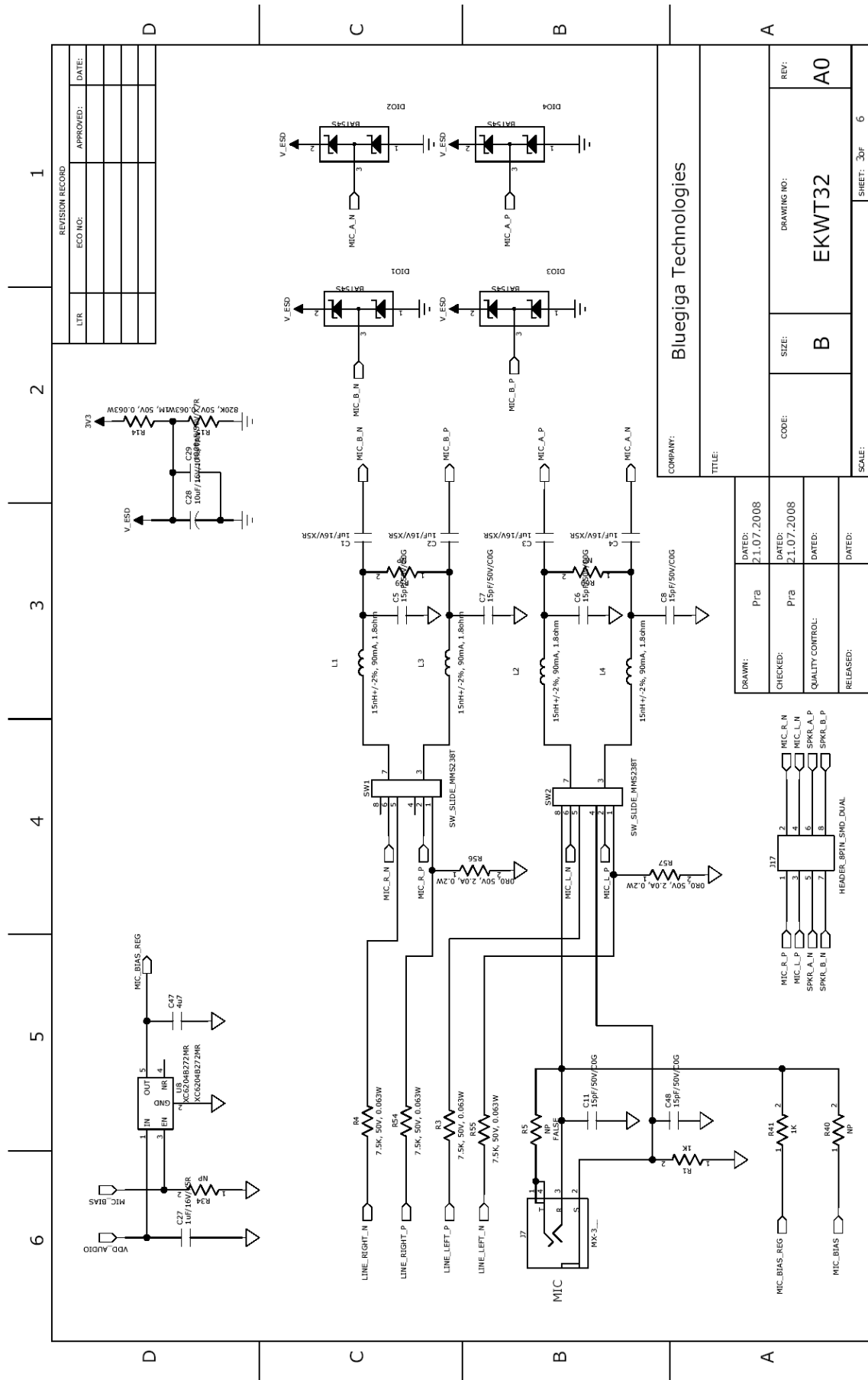

Figure 4: WT32 evaluation board schematic (3/6)

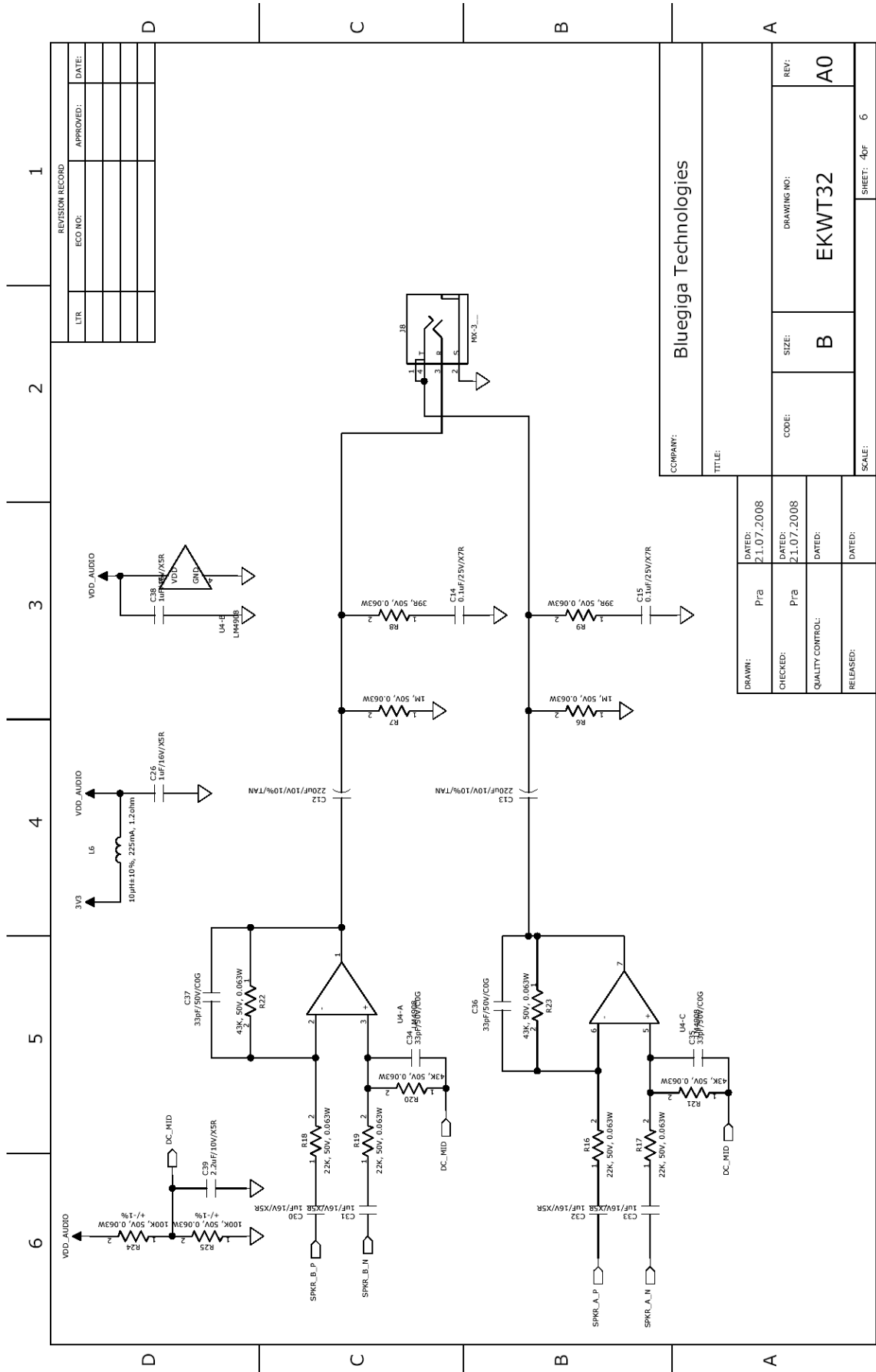

Figure 5: WT32 evaluation board schematic (4/6)

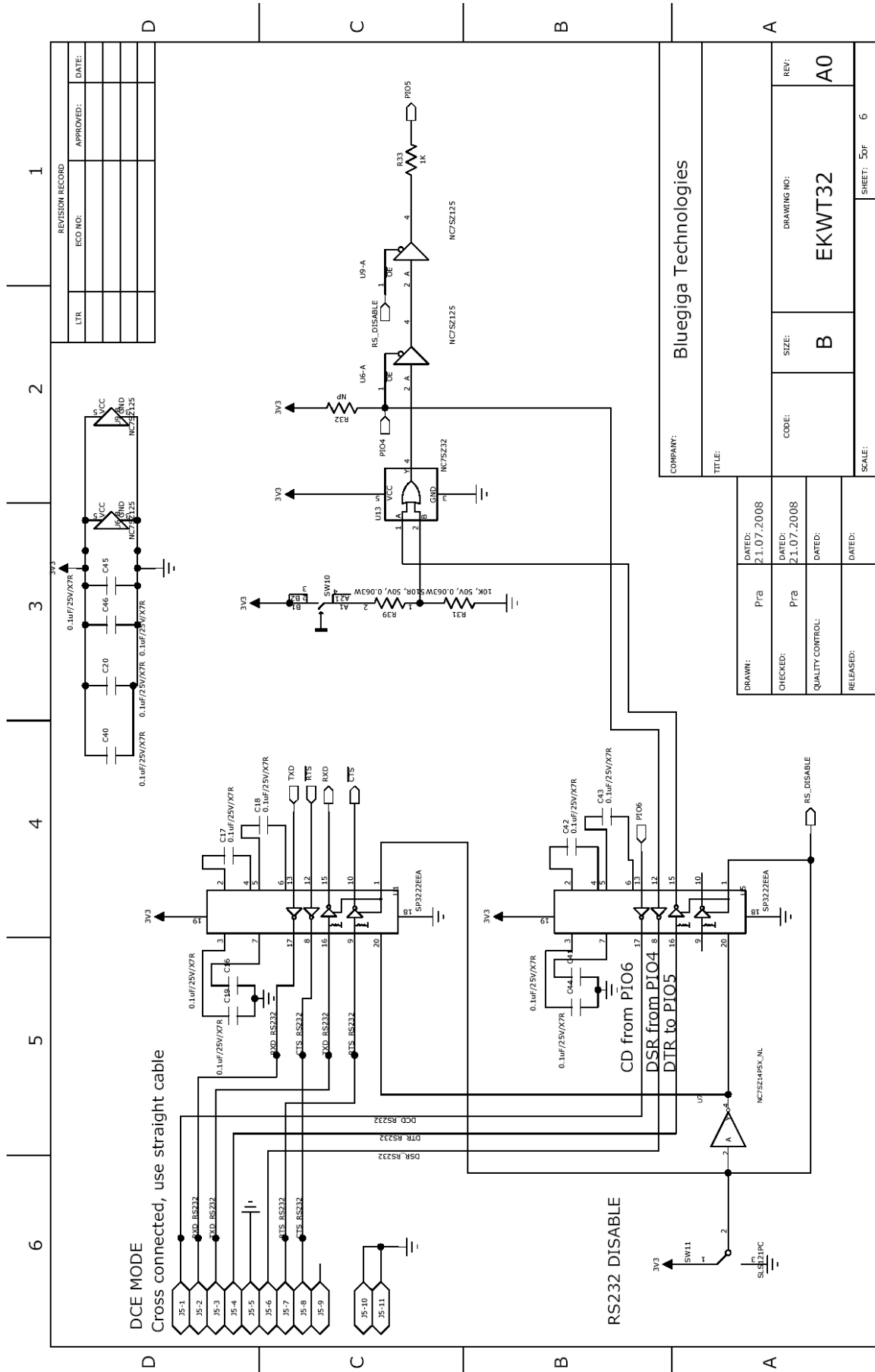

Figure 6: WT32 evaluation board schematic (5/6)



# 4 Assembly

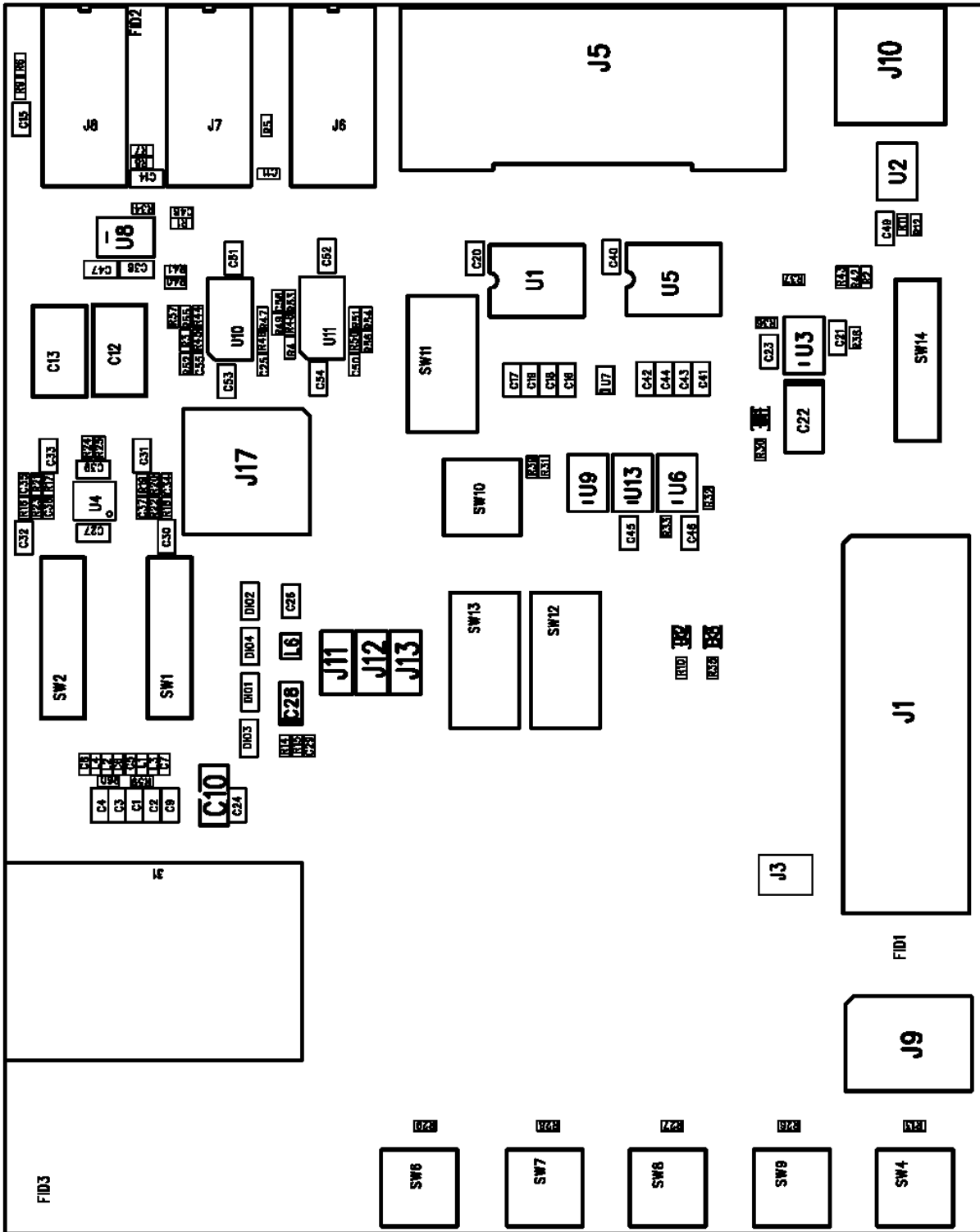

Figure 8: WT32 evaluation kit assembly

## 5 Layout

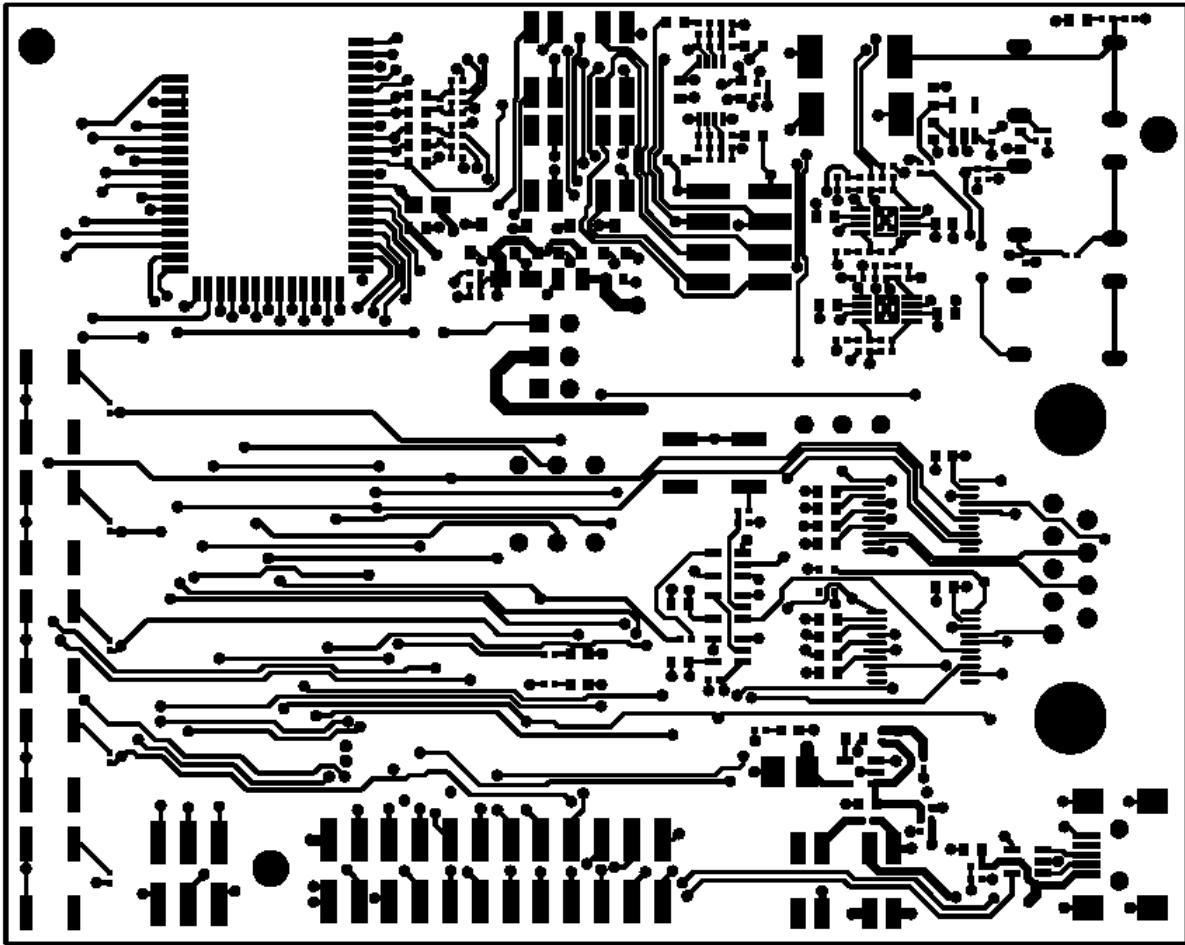

Figure 9: Layout top layer

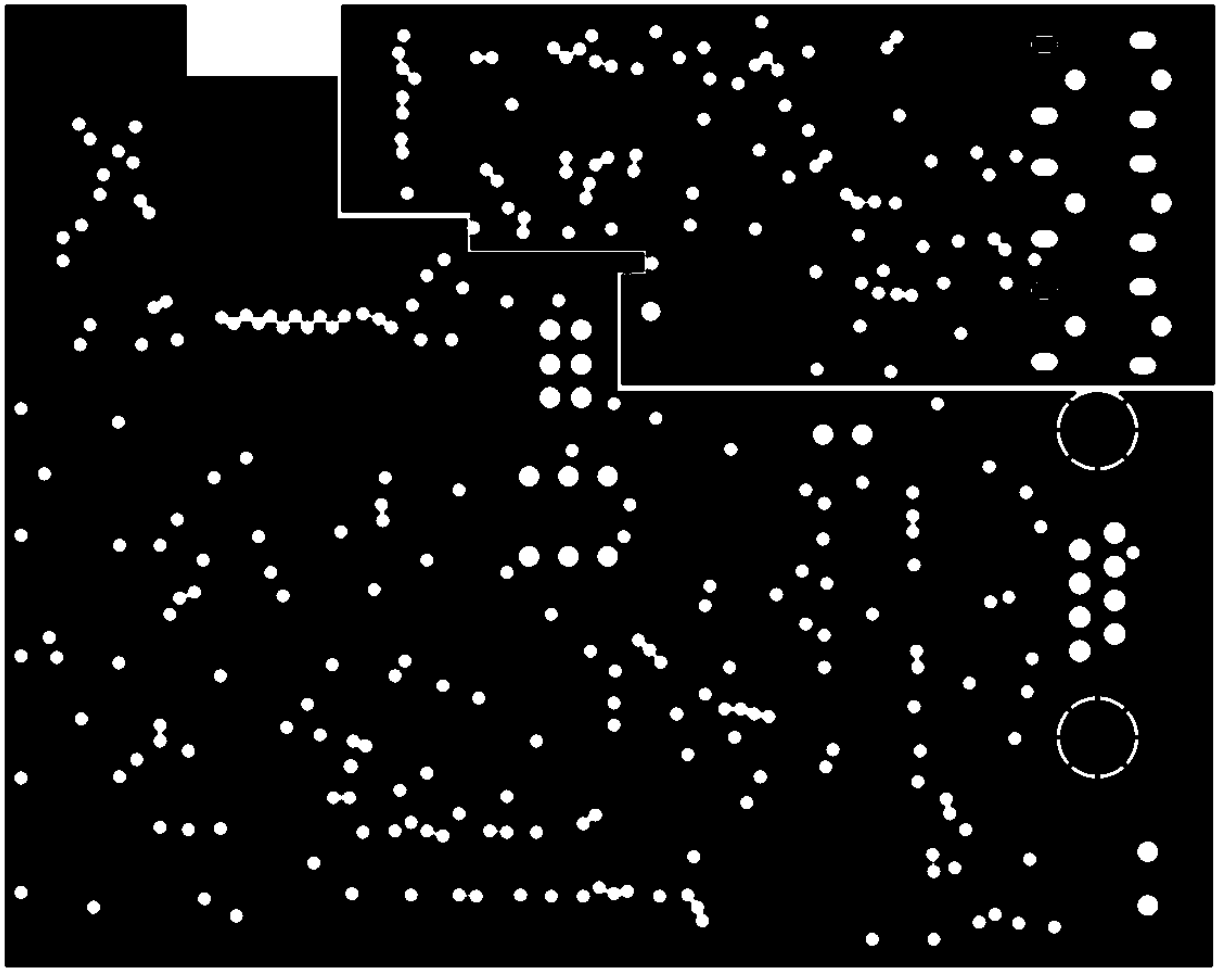

Figure 10: Layout second layer

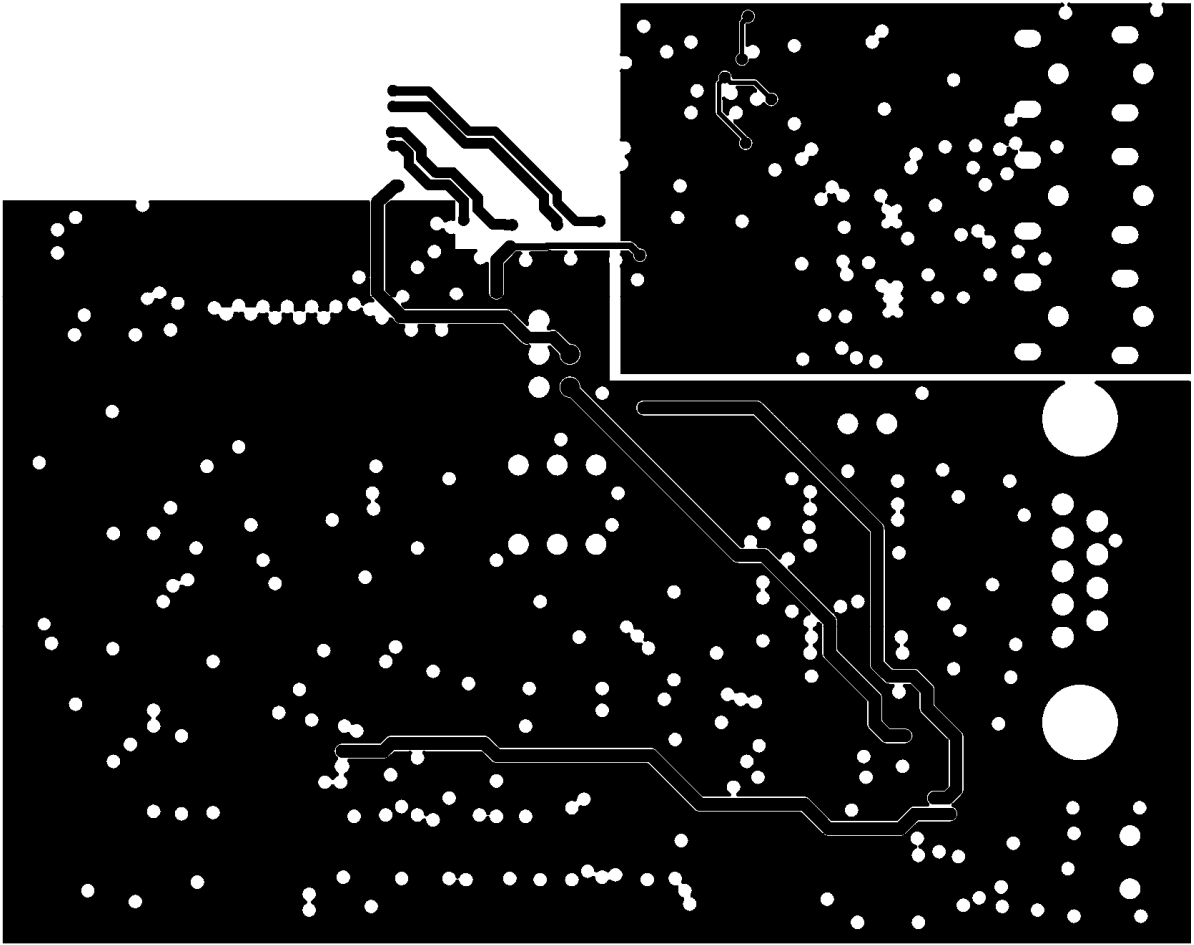

Figure 11: Layout third layer



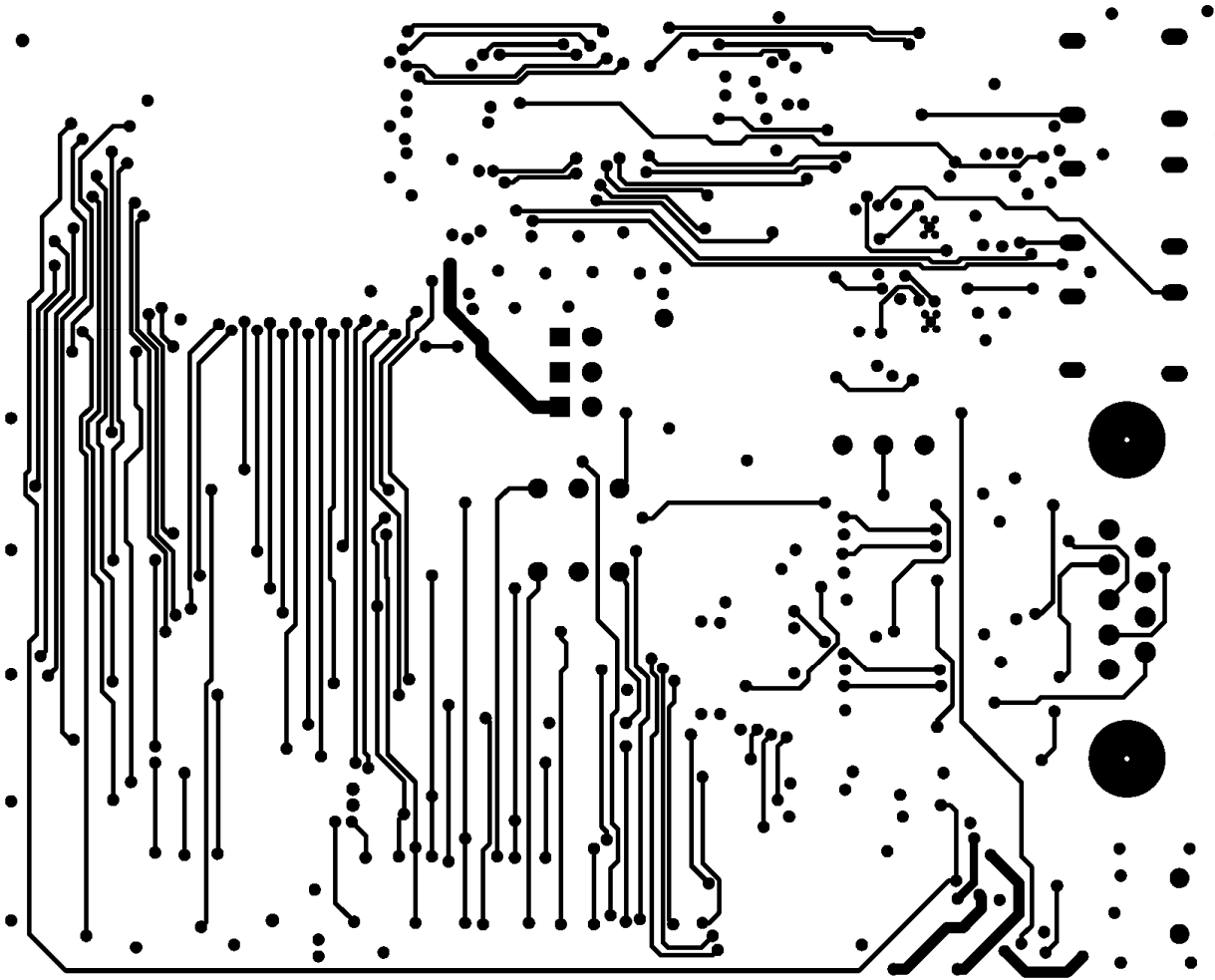

Figure 12: Layout bottom layer

## 6 Interfaces

### 6.1 Power Supply

The evaluation kit is powered from a 290 mAh lithium polymer battery. The battery can be charged through the USB interface. The charger starts when the 5 V is applied from the USB interface.

### 6.2 Stereo Line Input and Output

Stereo line input and output are available on 3.5 mm jack connectors. 1 M $\Omega$  resistors R6 and R7 remove any voltage charge on the connector and helps to prevent clicks and pops occurring when plugging the headphone for the first time.

R9 + C15 and R8 + C14 make a Zobel network. Its purpose is to tune out the inductance of the speaker coil and there by reduce cross over distortion. The value the components depend on the properties of the speaker coil and alternative values for the components may be required depending on the design.

U10 and U11 convert unbalanced stereo line input to fully differential. Fully differential line input for the module provides high common mode noise rejection improving RF immunity.

### 6.3 Microphone Input

Microphone takes the bias voltage from an external low noise regulator which is controlled by the mic\_bias line of WT32. The microphone is connected differentially through SW2 to the left channel audio input of the module.

### 6.4 SPI interface

SPI interface pin configuration is show in Table 2. The physical interface is 2X3 pin header.

PIN name	No.	I/O	Description
MISO	1	O	MISO
3.3 V	2	POWER	3.3 V power supply input
CLK	3	I	CLK
MOSI	4	I	MOSI
CSB	5	I	CSB
GND	6	GND	GND

**Table 1: SPI Interface PIN description**

## 6.5 UART Interface

UART interface is connected to both I/O pin header and the RS232 driver. When using UART through I/O interface the RS232 driver can be set to high impedance using SW11.

DTR button is connected to PIO5 through the DTR logic circuitry and a buffer. DSR is connected to PIO4. SW11 sets the DTR buffer to high impedance and thus when disabling RS232 interface through SW11, PIO5 can be configured to any purpose and used through the I/O interface. When you want to use the DTR signal, please refer to the iWRAP manual.

## 6.6 USB interface

USB interface consists of the ESD protection circuit U2 and a voltage divider network R11 and R12 (refer to the datasheet of WT32). PIO8 is connected for the USB interface through SW13.

## 7 WEEE Compliance



The crossed-out wheeled bin means that within the European Union the product must be taken to separate collection at the product end-of-life. Do not dispose of these products as unsorted municipal waste.

## 8 Contact Information

**Sales:** [sales@bluegiga.com](mailto:sales@bluegiga.com)

**Technical support:** [support@bluegiga.com](mailto:support@bluegiga.com)  
<http://www.bluegiga.com/techforum/>

**Orders:** [orders@bluegiga.com](mailto:orders@bluegiga.com)

**Head Office / Finland:**

Phone: +358-9-4355 060

Fax: +358-9-4355 0660

**Street Address:**

Sinikalliontie 5A

02630 ESPOO

FINLAND

**Postal address:**

P.O. BOX 120

02631 ESPOO

FINLAND

**Sales Office / USA:**

Phone: (781) 556-1039

Bluegiga Technologies, Inc.

99 Derby Street, Suite 200 Hingham, MA 02043